

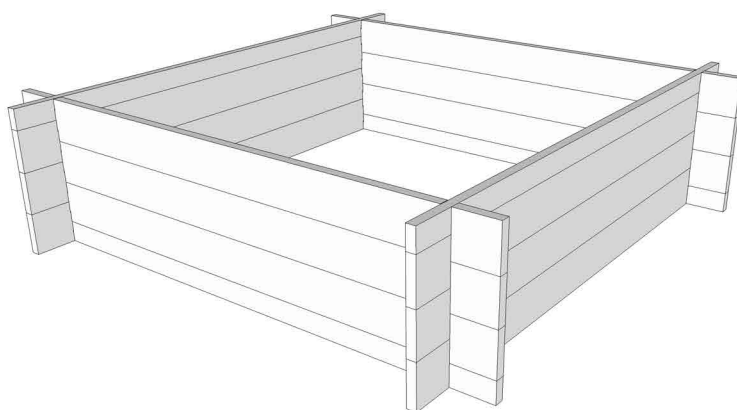

Vyvýšený záhon velký čtverec

K montáži jsou zapotřebí dvě dospělé osoby.



118 × 118 × 42 cm

2 × 6 ×

